







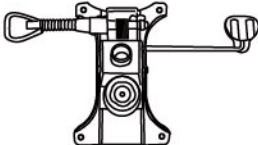
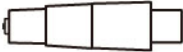

**IMPORTANT NOTICE:
HARDWARE PACKAGE IS ATTACHED
ON THE BOTTOM OF SEAT CUSHION.**

MODEL : B6776

(1)x1  Back	(2)x1  Seat	(3)x1 (L)x1 (R)  Right & Left Arm
(4)x1  Mechanism	(5)x1  Gas Lift	(6)x1  Base
(7)x5  Casters	<p>(A)*4  M8*22 Mechanism Screw</p> <p>(B)*8  M6*22 Arm Screw</p> <p>(C)*8  Arm Cap</p>	

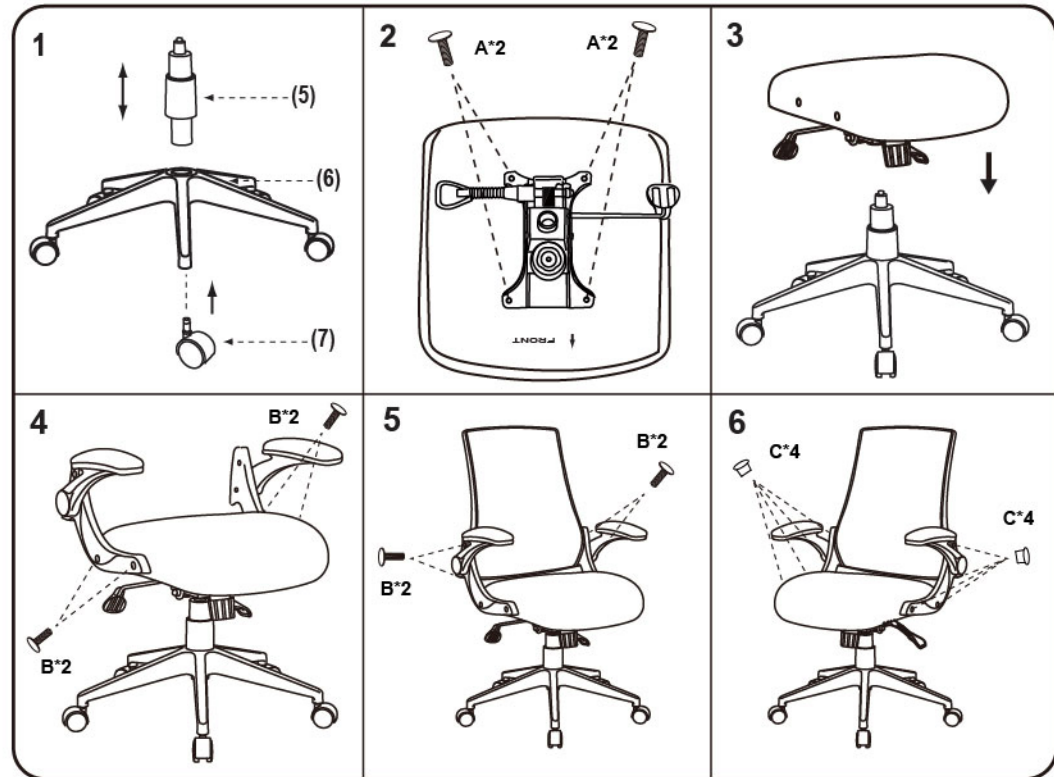

**Insert and loosely tighten all screws.
When assembly is completed, fully tighten
all screws before using. This chair is only
intended for sitting. Any other use will
void the warranty.**

