

Assembly Instruction

Insert and loosely tighten all screws. Failure to do this will cause holes not to line up properly. When assembly is completed, fully tighten all screws before using. This chair is only intended for sitting. Any other use will void the warranty.





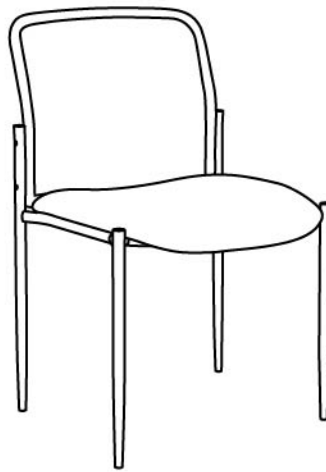

CAUTION : Edges of some parts may be sharp. Please handle unassembled parts carefully.

B6909

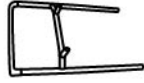

B6919



Parts List	Q'ty
①  Right & Left Frame	2
②  Connecting Bar	2
③  Long Screws M6*36	4
④  Short Screws M6*30	4
⑤  Seat Cushion	1
⑥  Back Cushion	1

1 Frame & Tube

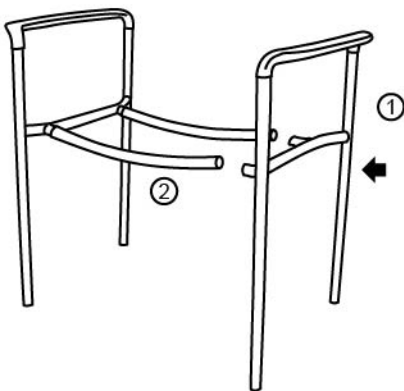

2 Seat & Frame

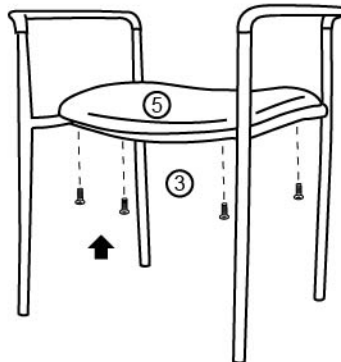

3 Back Joint

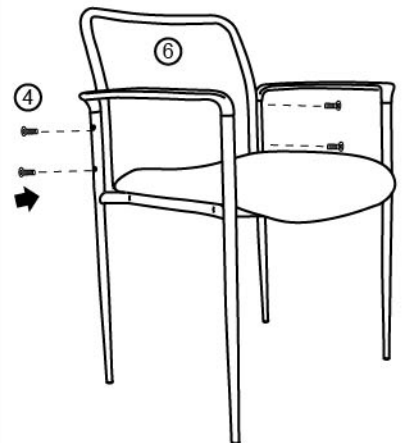

IMPORTANT NOTICE:
HARDWARE PACKAGE IS ATTACHED ON THE BOTTOM OF SEAT CUSHION.