

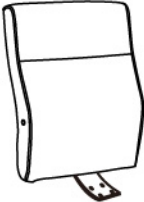





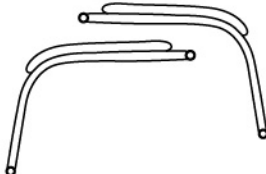

**IMPORTANT NOTICE:
HARDWARE PACKAGE IS ATTACHED
ON THE BOTTOM OF SEAT CUSHION.**

MODEL: B696

(1)X1 	(2)X1 	(3)X1 (L)x1 (R) 
BACK (4)X1 	SEAT (5)X1 	ARM (6)X5 
(7)X1 	<p>(A)X4  M8*45 ARM SCREW</p> <p>(B)X4  M8*30 L-BAR SCREW</p> <p>(C)X4  M8*22 MECHANISM SCREW</p> <p>(D)X4  ARM CAPS</p> <p>(E)X1  ALLEN KEY</p>	
MECHANISM		

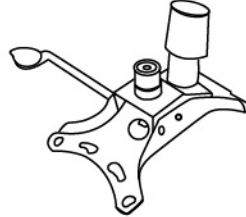
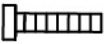
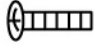
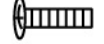

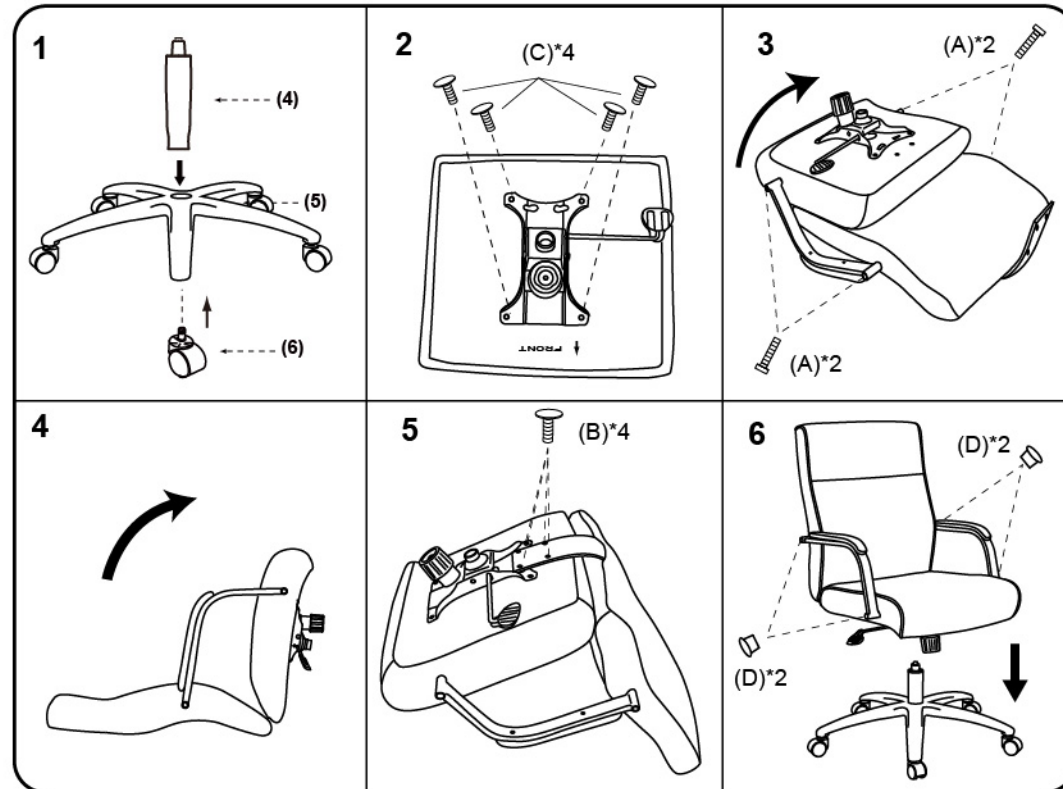
Insert and loosely tighten all screws. When assembly is completed, fully tighten all screws before using. This chair is only intended for sitting. Any other use will void the warranty.

