

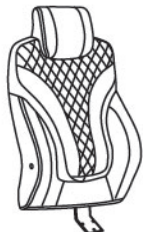







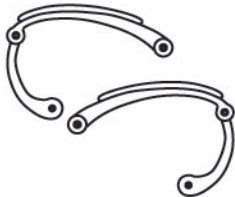
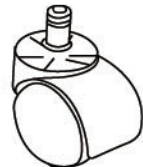

**IMPORTANT NOTICE:
HARDWARE PACKAGE IS ATTACHED
ON THE BOTTOM OF SEAT CUSHION.**

MODEL:B8871

| | | |
|--|--|---|
| (1)x1 | (2)x1 | (3)x1 (L)x1 (R) |
|  |  |  |
| Back Cushion | Seat Cushion | Left- Arm Right- Arm |
| (4)x 5 | (5)x1 | (6)x1 |
|  |  |  |
| Caster | Gas Lift W/ Cover | Base |
| (7)x1 | <p>(A)x4  M8*22 Mechanism Screw</p> <p>(B)x3  M8*18 L-bar Screw</p> <p>(C)x4  M8*55 Arm Screw</p> <p>(D)x4  Arm Cap</p> <p>(E)x1  Allen Key</p> | |
|  | Mechanism | |

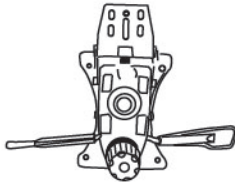
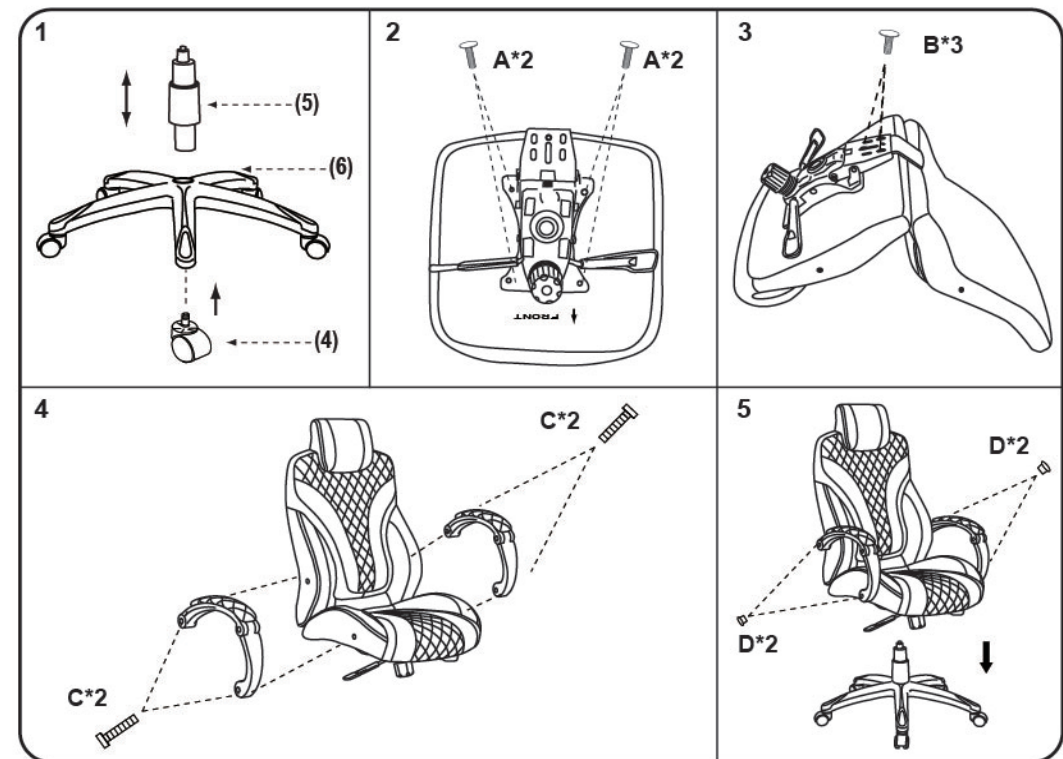

Insert and loosely tighten all screws. When assembly is completed, fully tighten all screws before using. This chair is only intended for sitting. Any other use will void the warranty.

