

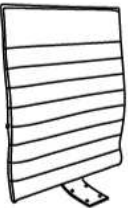







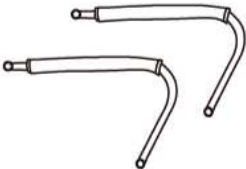

**IMPORTANT NOTICE:  
HARDWARE PACKAGE IS ATTACHED  
ON THE BOTTOM OF SEAT CUSHION.**

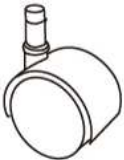
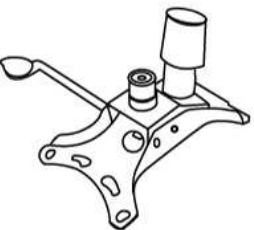
MODEL: B9533C B9534C

(1)X1  BACK	(2)X1  SEAT	(3)X1 (L)x1 (R)  ARM
(4)X1  GAS LIFT	(5)X1  BASE	(6)X5  CASTERS
(7)X1  MECHANISM	<p>(A)X4  M8*22 MECHANISM SCREW</p> <p>(B)X4  M8*36 ARM SCREW</p> <p>(C)X4  M6*30 L-BAR SCREW</p> <p>(D)X4  ARM CAPS</p> <p>(E)X1  ALLEN KEY</p>	

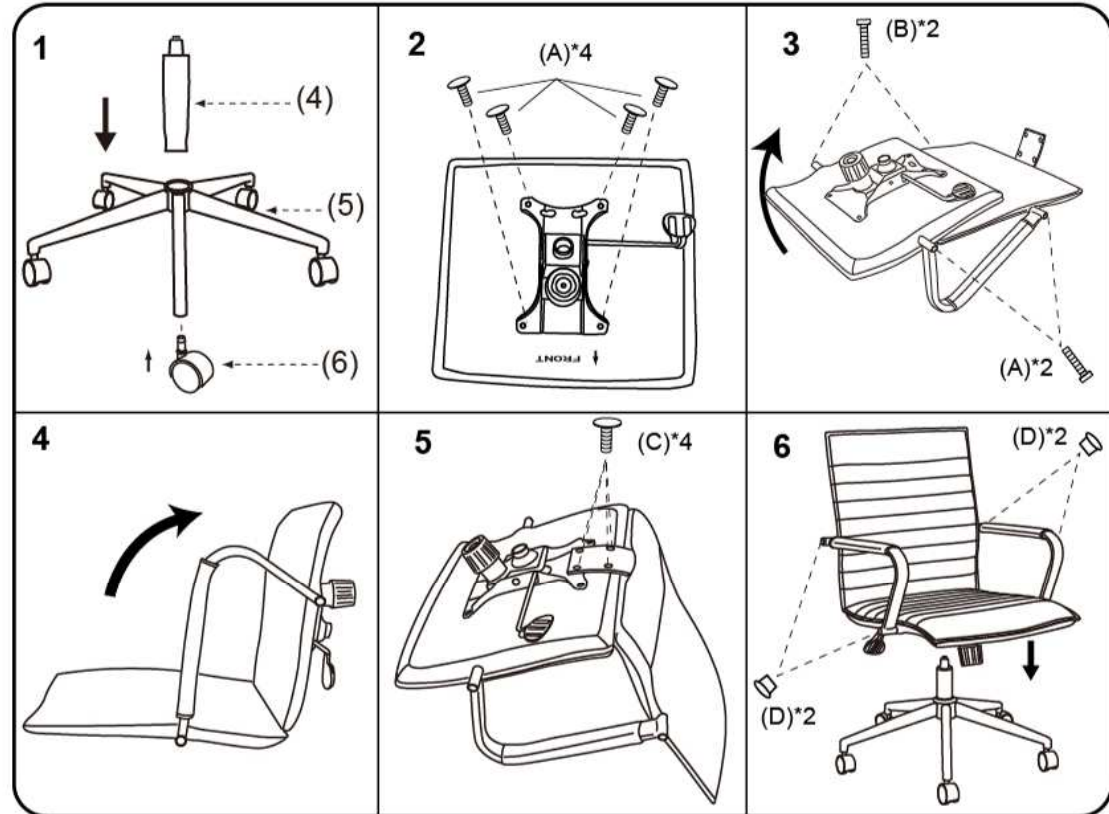

**Note: Please tighten all arm screws using allen key before step 6**

**Insert and loosely tighten all screws. When assembly is completed, fully tighten all screws before using. This chair is only intended for sitting. Any other use will void the warranty.**

