

35080

ShredMATIC®

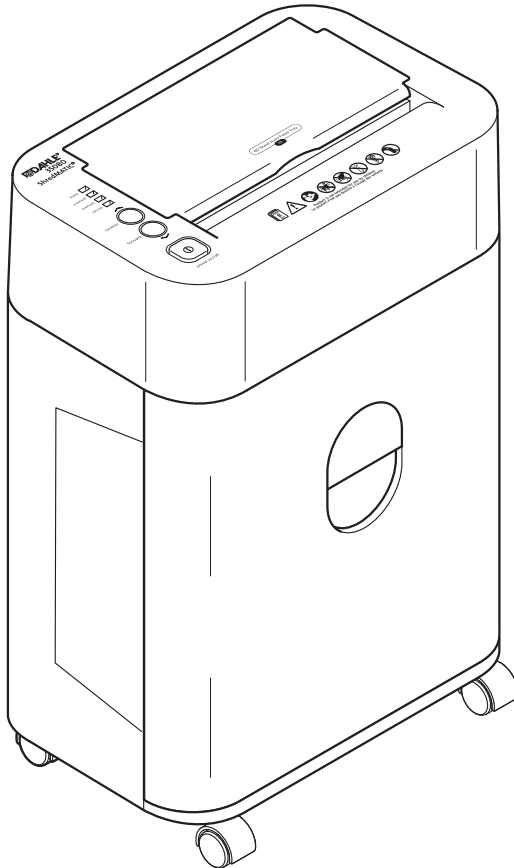

MyBinding.com
5500 NE Moore Court
Hillsboro, OR 97124
Toll Free: 1-800-944-4573
Local: 503-640-5920

DAHLE®

**en Instructions****IMPORTANT!**

Read the operating and safety instructions BEFORE placing the document shredder into operation.



You must follow the instructions.

Keep the operating instructions in a safe place ready for later use.

Table of Contents

1	Important information	6
1.4	Scope of supply	60
1.5	Technical specifications	60
2	Operation	61
2.4	Paper shredding	62
2.10	Card shredding	64
3	Maintenance / troubleshooting	65
3.1	Emptying shredding waste	65
3.4	Overheated	66
3.5	Overload	66
3.15	Cleaning the shredder	69

1.1 Intended use, warranty

The document shredder is intended to be used for shredding paper.

Depending on the model variant, a small amount of the following materials can also be shredded:

- CDs/DVDs, bank cards and credit cards (see technical data).
- The normal staples and paper clips found in paper documents (exception: security level P6 and P7 devices).

Wear, damage due to improper use or unauthorised modifications and repairs are not covered by the warranty or the guarantee.

The document shredder was designed for private use and for use in normal office environments.

The following conditions apply to the performance in terms of sheets listed under technical data:

Maximum number of sheets that are shredded in one pass under the following conditions: New cutting rollers, oiled if needed, cold motor, power supply with nominal voltage and nominal frequency (230 V/50 Hz; 120 V/60 Hz). Deviations may result in reduced sheet processing and increased operating noises. The sheets are fed centrally and lengthwise at a 90 degree angle. The performance in terms of sheets can also vary depending on the paper properties and input.

1.2 Safety instructions

- Do not place the device near a source of heat.
- Store, transport and operate the device in an upright position only.
- Only use liquids and gases on the device that comply with DAHLE guidelines.
- Do not open up the device.
- Only operate the device in closed spaces, at temperatures of between 10 °C and 25 °C (50 °F to 77 °F) and at a non-condensing humidity of between 15% and 95%.
- Ensure that the building installation has short-circuit protection: max. 16 A (US max. 20 A).
- Do not operate the document shredder without inserting documents.
- The device is not intended for use by persons (including children) with restricted physical, sensory or mental capabilities or a lack of experience and knowledge, unless they are working under supervision or receive detailed instruction about how to use the device from a person who is responsible for safety.



Dispose of the document shredder properly in an environmentally friendly way at an authorised collection point. Do not dispose of any parts of the document shredder or packaging in domestic waste.



1.3 Key to pictograms



Important information



User information/safety instructions



WARNING



Do not use near caustic substances.



Place the device in a stable position on the floor, leaving a gap of 100 mm to the wall, ensure no heat can accumulate, engage brake mechanisms (depending on type)



Do not use near inflammable liquids or gases.



Automatic start-up



Do not expose to moisture



This document shredder is not intended to be used by children (the product is not a toy).



Do not touch the paper feed with your hands.



Do not allow items of clothing to come into contact with the paper feed.



Do not allow your hair to come into contact with the paper feed.



Keep spray cans away from the device.



Remove paper clips and staples before shredding.



Do not insert any diskettes/CDs/DVDs.



Disconnect the document shredder from the electrical power supply before performing maintenance work.



Technical specifications - Subject to technical modifications.



Noise level when operated without shredding documents



Intake speed



Shredded paper particles



Shredded card particles



Weight



The power plug is used to disconnect the power supply.



The mains socket must be easily accessible at all times.



How to use



Document shredder on standby



Document shredder in operation



Automatic shut-down!



The document shredder will switch off automatically to cool down if used for a long time and /or if overloaded



Maintenance instructions / troubleshooting



Container full



Possible malfunctions



Automatic switch-off when housing is open

MyBinding.com
5500 NE Moore Court
Hillsboro, OR 97124
Toll Free: 1-800-944-4573
Local: 503-640-5920

1



1.4

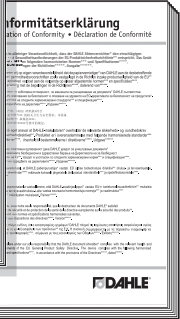
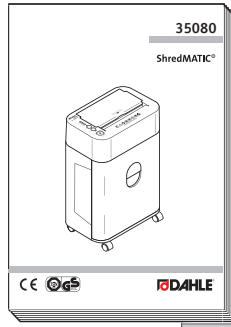
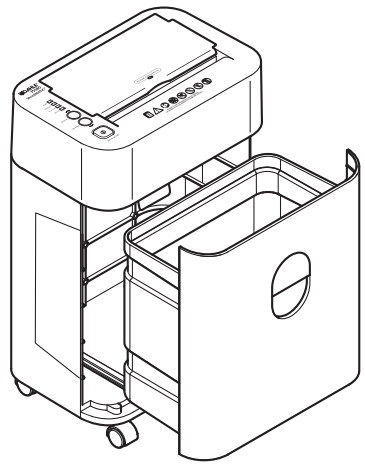

1.5

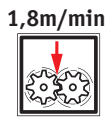
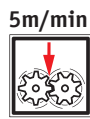
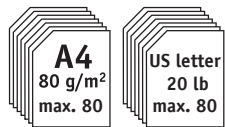

220 - 240 V / 50 - 60 Hz
110 - 120 V / 50 - 60 Hz

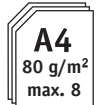
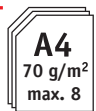
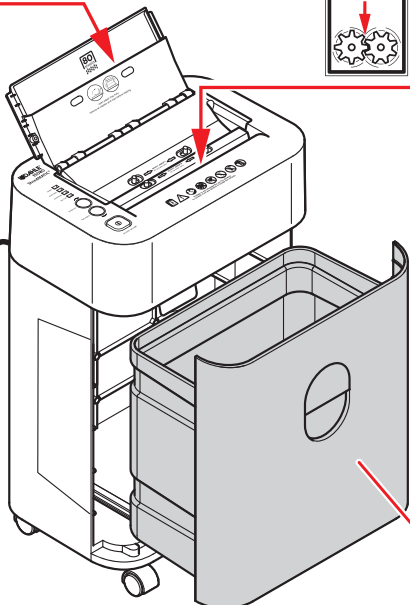
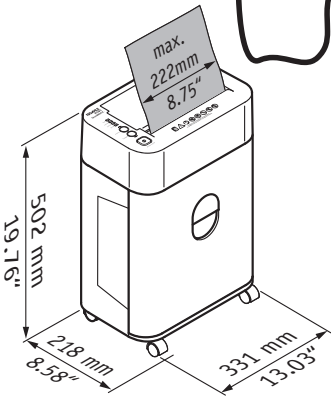
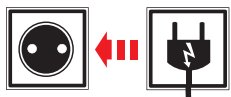

DIN 66399
P-4 / F-1



4,3 x 10 mm

DIN 66399
T-4 / E-2



max 1



≤68 dB (A)



8,4 kg
18.5 lbs



17 l / 4.5 gal



2.1



2.2

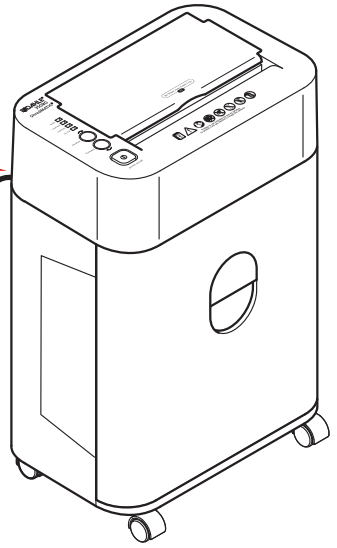
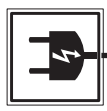
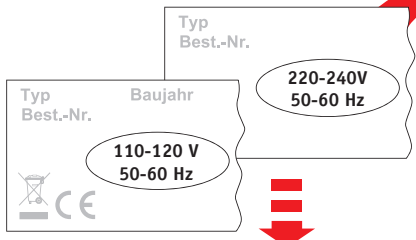

2.3

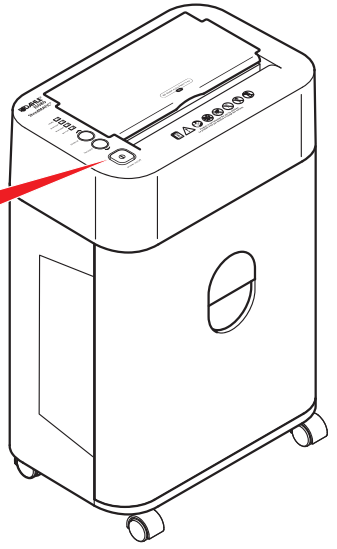
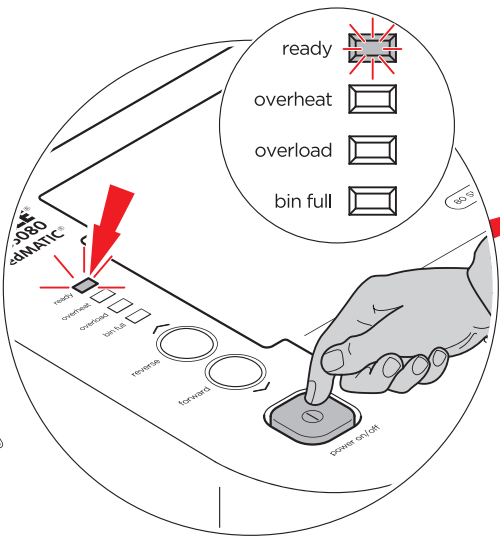

2



2.4



2.5

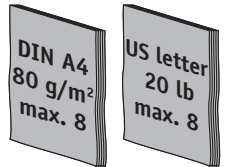
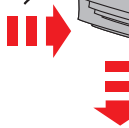
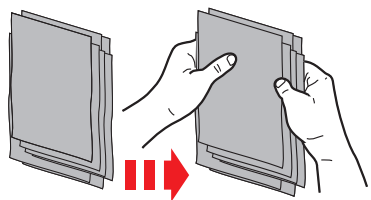

O.K.

O.K.

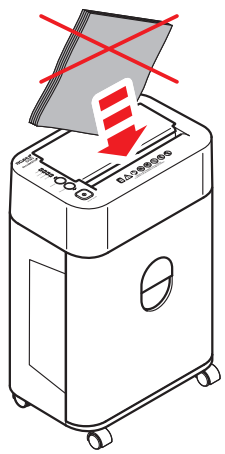
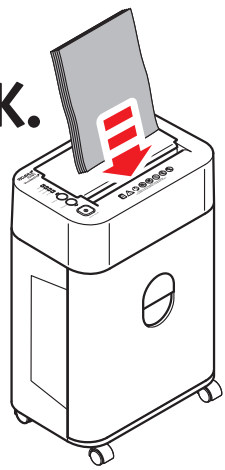

2.6

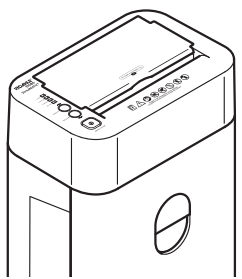
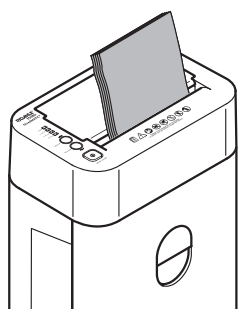
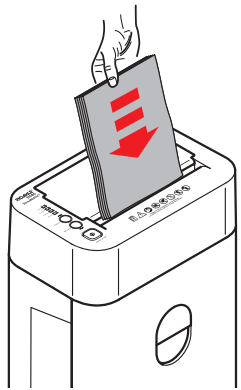

2



2.7

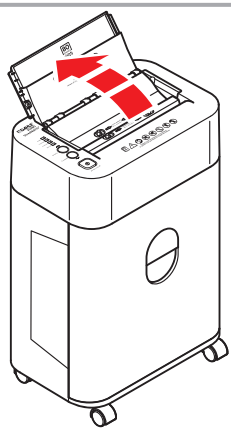
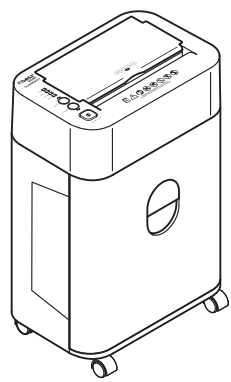

O.K.

2.8

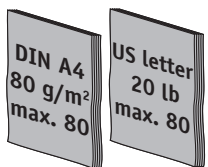
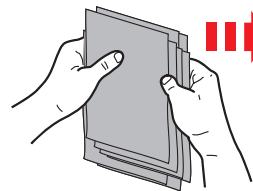

O.K.

O.K.

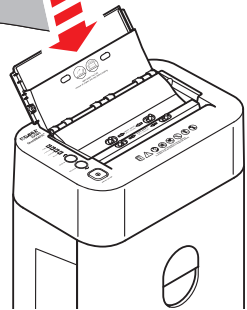
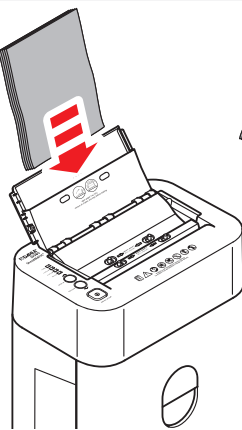

2.9

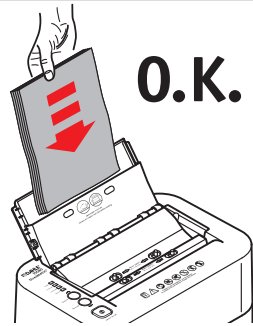

O.K.

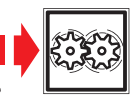
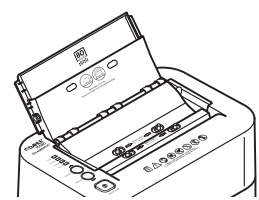
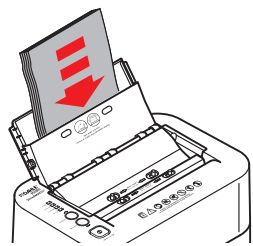

2



2.10



2.11



max. 1

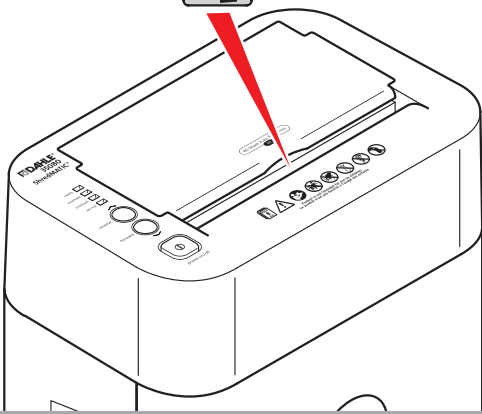

O.K.

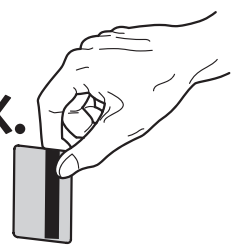

~~O.K.~~

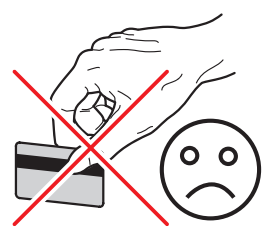

2.12



max. 1

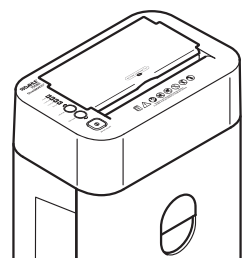
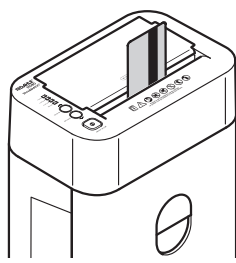
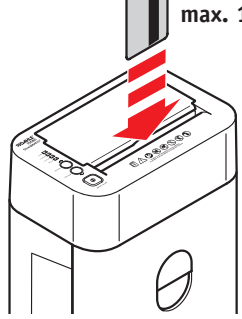



3.1



~~O.K.~~

- ready
- overheat
- overload
- bin full

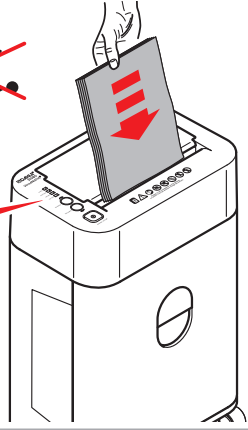
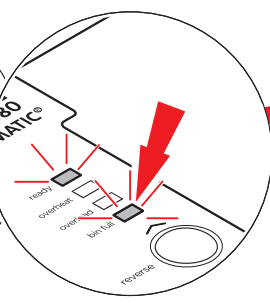

3.2

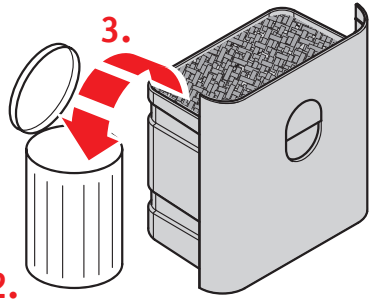
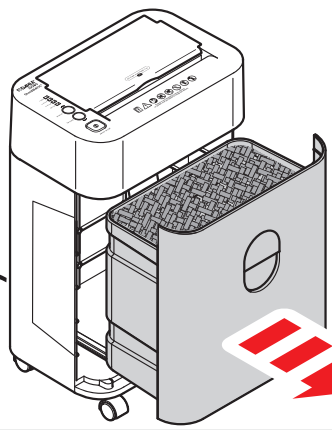

2.3

3.3



- ready
- overheat
- overload
- bin full

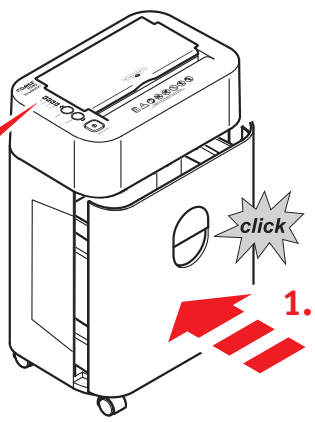
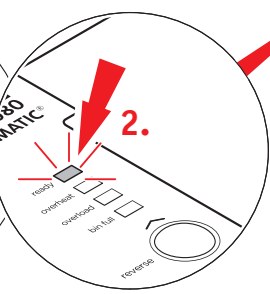



3.4



ready

overheat

overload

bin full

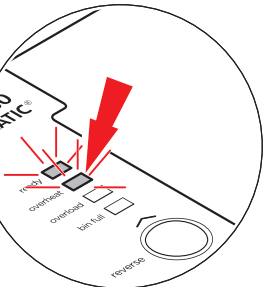

2.5

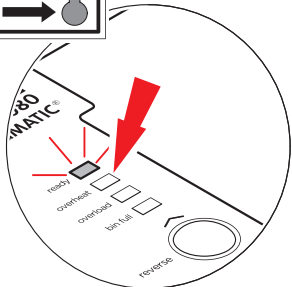

3.5



ready

overheat

overload

bin full

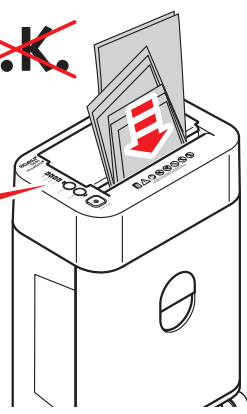
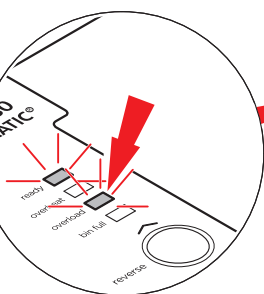

3.6

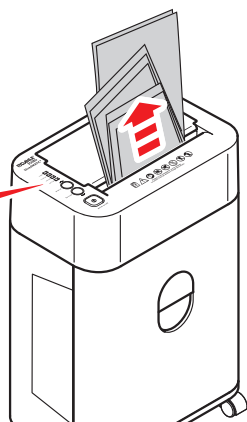
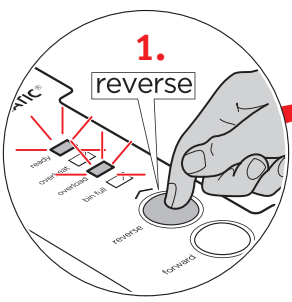

2.

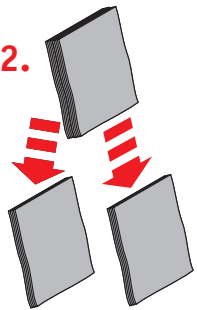

2.5



3.7



- ready
- overheat
- overload
- bin full

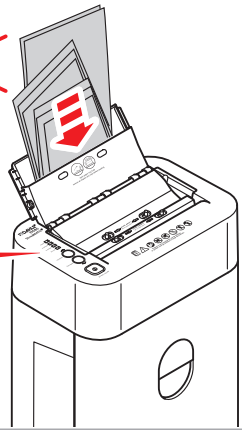
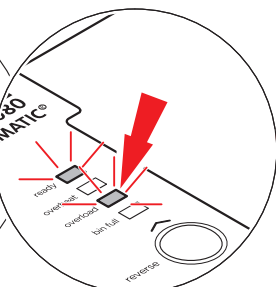

3.8

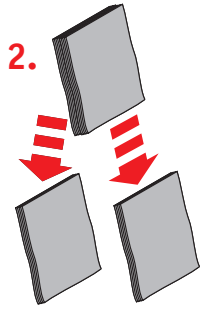
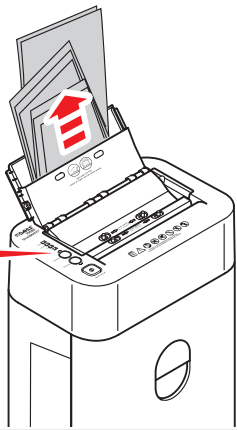
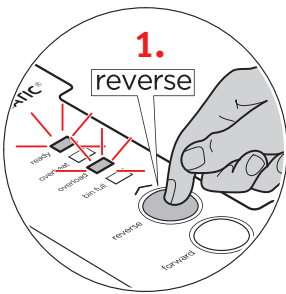

3.9

- ready
- overheat
- overload
- bin full

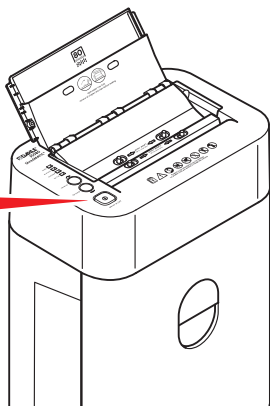



3.10

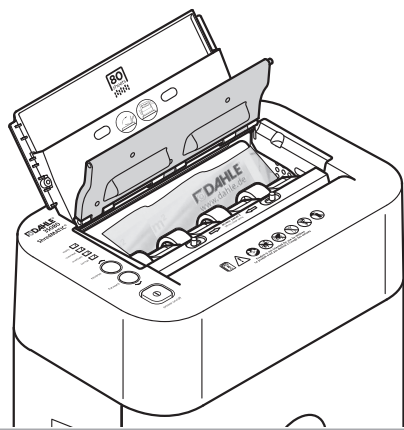
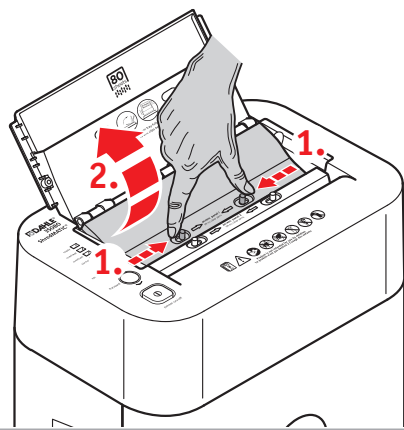

3.11

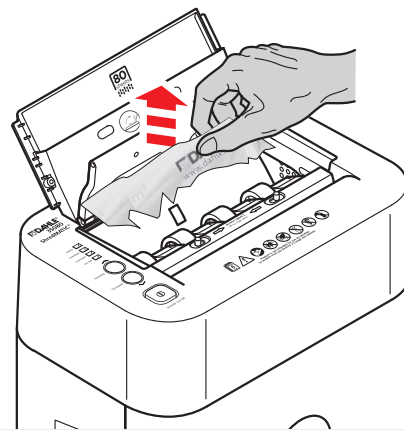

3.12

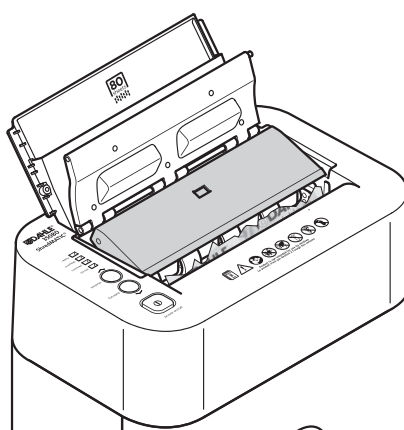
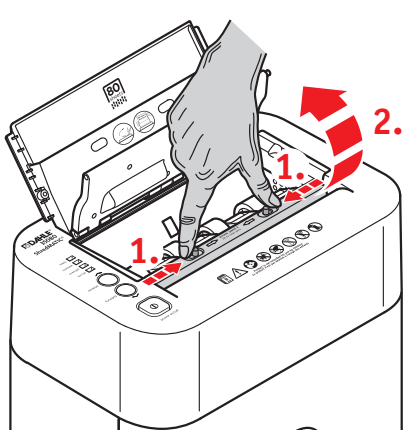



3.13

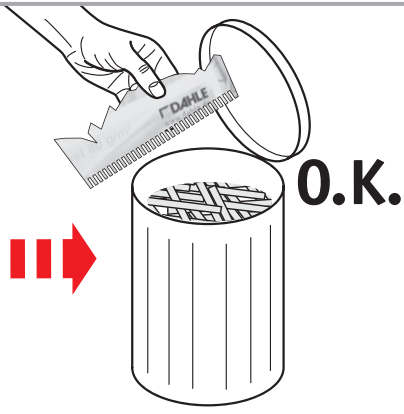
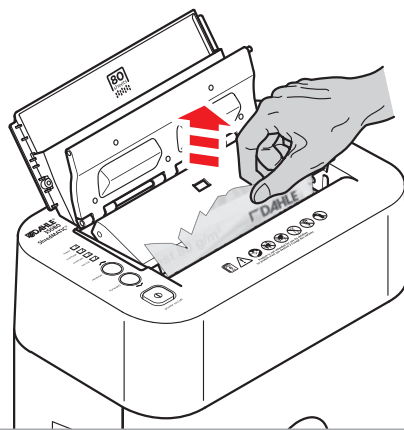

3.14

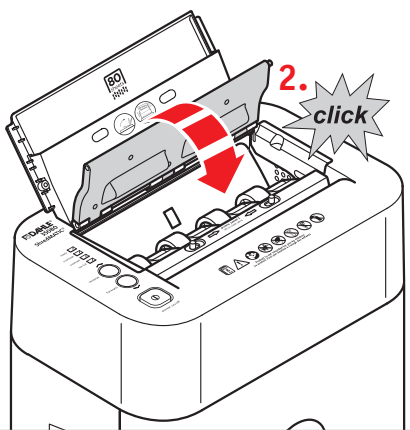
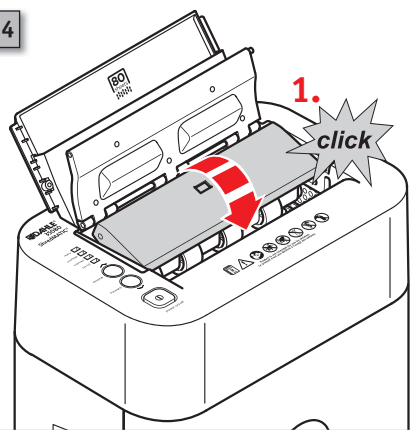

⇒ 2.2

3.15



1. ⇒

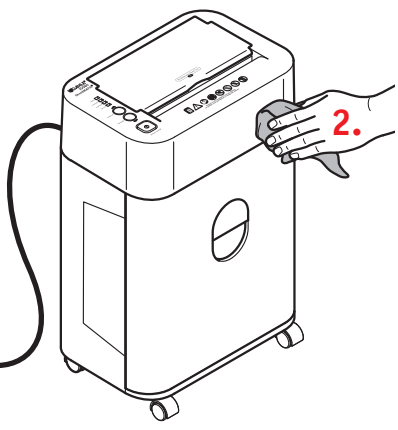
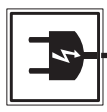

MyBinding.com
5500 NE Moore Court
Hillsboro, OR 97124
Toll Free: 1-800-944-4573
Local: 503-640-5920