

Side-Belt Adjustable Carton Sealer

Model:

CT-50

Excellent for low profile, small, lightweight boxes.

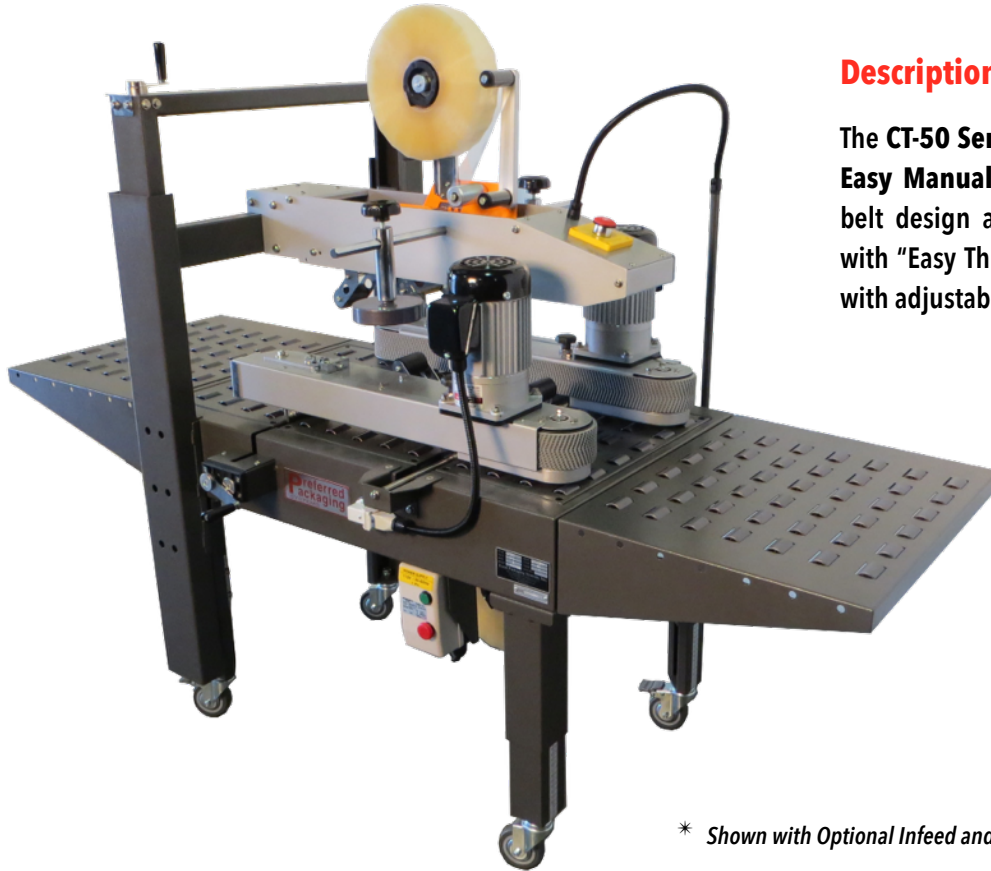

Description

The CT-50 Semi-Automatic Uniform Carton Sealer with Easy Manual Carton Size Adjustment has a side-drive belt design and features our new "Piranha" tape head with "Easy Thread Design." The machine comes complete with adjustable height legs, power cord and plug.

** Shown with Optional Infeed and Discharge Roller Conveyor & Casters*

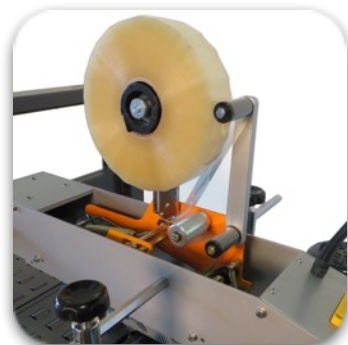

**Patented "Easy Thread" Tape Design
With Adjustable Box Side Guides.**

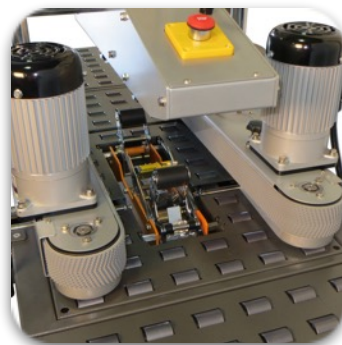

**Heavy Duty Side Drive Belts
For Positive Grip Pressure.**



**New "Piranha" Tape Head Features An
Easy Thread Design with Optimizer Arm.**

CT-50 CARTON SEALER

The operator simply folds the top flaps of the corrugated carton and feeds it into the machine. The CT-50 applies a single tape strip to both the top and bottom of the case simultaneously. This two belt drive design is a heavy duty versatile machine designed for dependable performance and easy operation. The CT-50 can be easily adjusted in only seconds to process a different size carton. Excellent for low profile, small, lightweight boxes.

STANDARD FEATURES:

- "Piranha" Tape Head with "Easy Thread" Design
- Interchangeable Tape Heads
- Side Pressure Rollers to Close Box Top
- 2 Side Drive Belts for Positive Feed
- Fully Adjustable Legs

OPTIONAL FEATURES:

- 3" (72mm) Tape Heads
- Infeed Conveyor
- Exit Conveyor
- Stainless Steel Frame
- Heavy Duty Locking Casters

CARTON SIZE: LENGTH: 6" min. to Infinite
WIDTH: 4.5" min. to 20" max.
HEIGHT: 4" min. to 20" max.

MACHINE SIZE: 36"L x 27"W x 53"H

MACHINE SPEED: 75ft./min. up to 2000 cartons per hour. Production rate depends on carton size and operator dexterity

ELECTRICAL: 110 Volt, 1 Phase, 10 Amp

WEIGHT: 320 lbs. Shipping Weight: 370 lbs.

MAX BOX WEIGHT: 65lbs.

TAPE HEAD SPECS: 2" (48mm) Wide - 1,000 yard or 1,500 yard rolls.

WARRANTY: 1 Year Limited Warranty

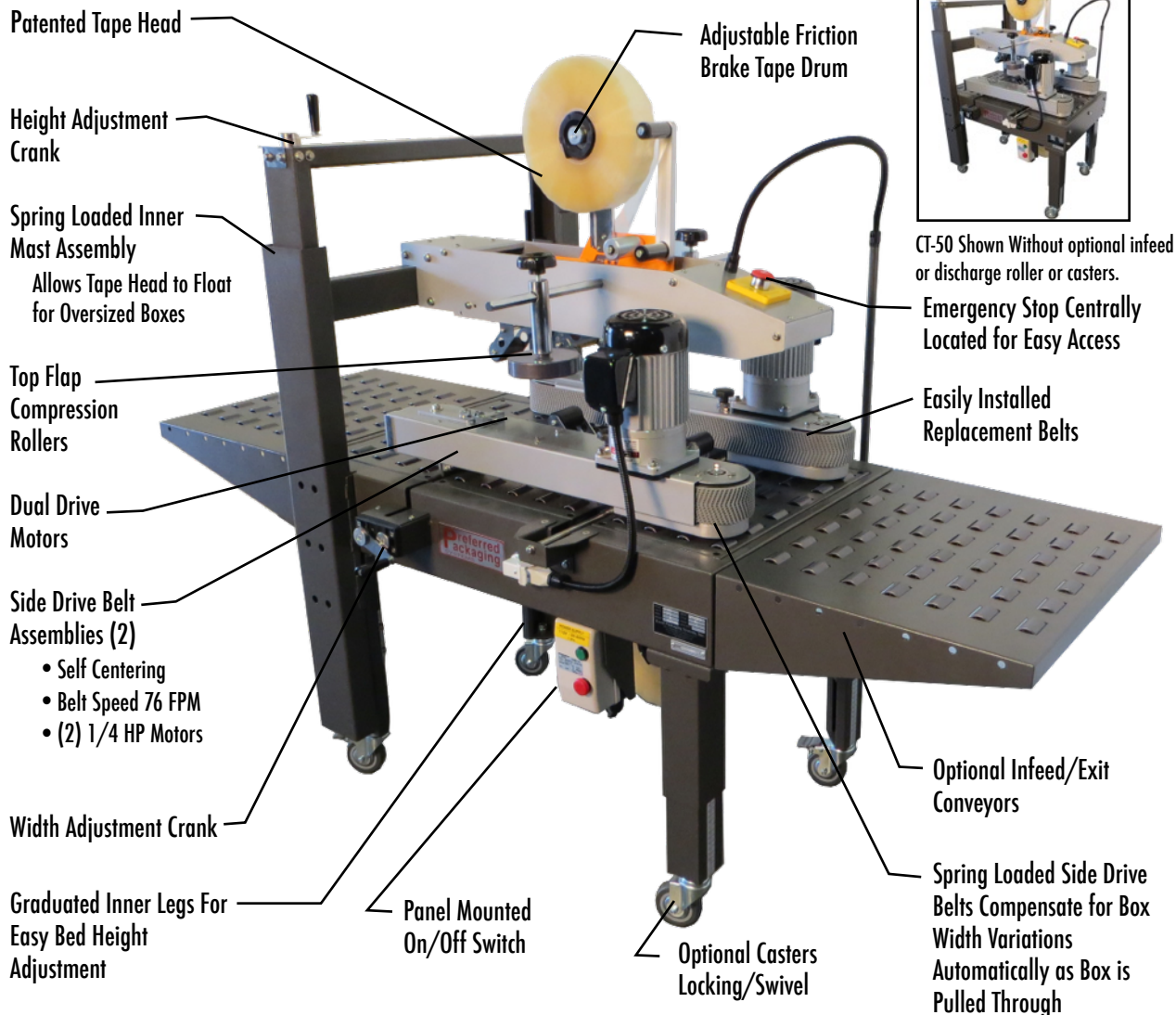
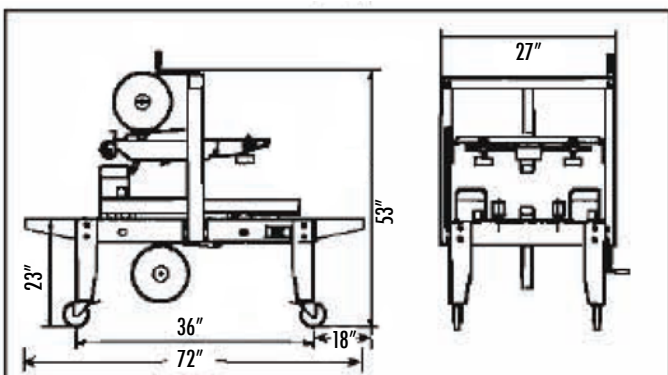

CT-50 Shown Without optional infeed or discharge roller or casters.

BOXES PER MINUTE vs. BOX LENGTH

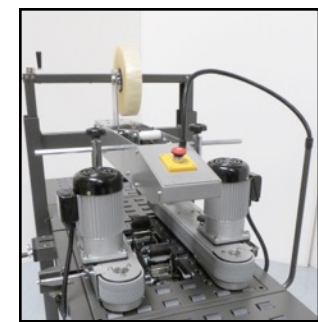
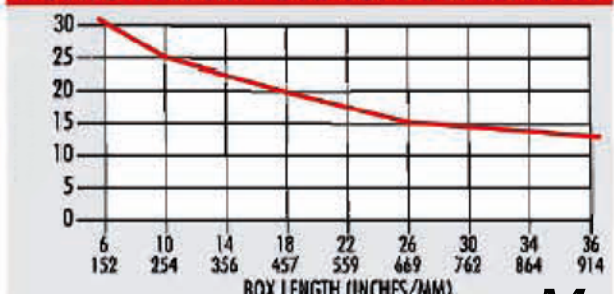

Model CT-75 uses 3" (72mm) Tape Heads