

Dahle 40334 High Security Level P-7 Micro Cut Paper Shredders

Instruction Manual



Provided by

MyBinding.com
When Image Matters.

Call Us at 1-800-944-4573

40204 - 40634



- DE** Bedienungsanleitung
- UK/US** Operating instructions
- FR** Instructions de service
- ES** Manual de instrucciones
- IT** Istruzioni per l'uso
- PT** Manual de instruções
- NL** Gebruiksaanwijzing





General information

Prior to placing in operation the document shredder, read the operating instructions and safety instructions carefully!
Keep the instructions for later use.

- Only store, transport and operate the document shredder in an upright position!
- Only use liquids and gases that comply with DAHLE guidelines on the document shredder!
- The document shredder must only be operated in closed rooms at temperatures of 15 °C to 32 °C and with a non-condensed humidity of 15% to 95%!
- Do not place the document shredder near a source of heat!
- Ensure the document shredder is standing firmly on the floor and with a distance of 100 mm to the wall; activate brakes and fasten using the mounting kit if supplied!
- Avoid any accumulation of heat!
- The mains socket must be easily accessible at all times!
- Only use the mains cable supplied by DAHLE!
- It is to be ensured the installation in the building is protected against short circuits (max. 20 A)!
- Do not use near inflammable liquids or gases!
- Do not use near caustic substances!
- Do not subject to moisture!
- Remove paper clips and staples prior to shredding!
- Starts automatically!
- Do not operate the document shredder without inserting documents!



- 1 - Follow safety regulations!
- 2 - **Prior to placing in operation the document shredder, read the operating instructions and safety instructions carefully!**
- 3 - This document shredder is not intended to be used by children (the product is not a toy)!
- 4 - Do not touch the paper feed with your hands!
- 5 - Do not allow items of clothing to touch the paper feed!
- 6 - Do not allow your hair to touch the paper feed!
- 7 - Prior to maintenance work, disconnect the document shredder from the electrical power supply!

Pay attention to warnings!

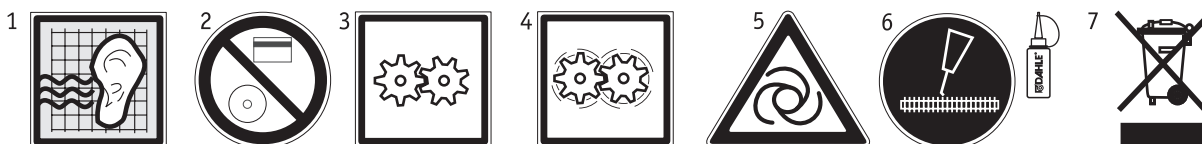

- 1 - Noise in operation without shredding documents (in accordance with DIN)
- 2 - Do not shred CDs/DVDs or bank cards/credit cards!
- 3 - Document shredder in standby
- 4 - Document shredder in operation
- 5 - Starts automatically
- 6 - Oiling (only use DAHLE oil!)
- 7 - Dispose of the document shredder appropriately and in an environmentally friendly manner at an authorised collection point. Do not dispose of any parts of the document shredder or packing in domestic waste.



General information

Intended use, warranty

The document shredder is intended to be used for shredding paper.

Depending on the model variant, a small amount of the following materials can also be shredded:

CDs/DVDs, bank cards and credit cards (see technical data)

Wear, damage due to improper use or unauthorised modifications and repairs is not covered by the warranty or the guarantee.

Subject to technical change!

Remove transport lock!

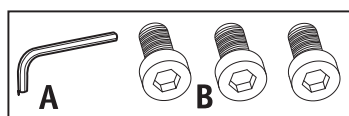
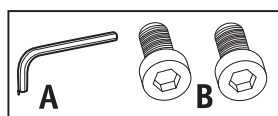
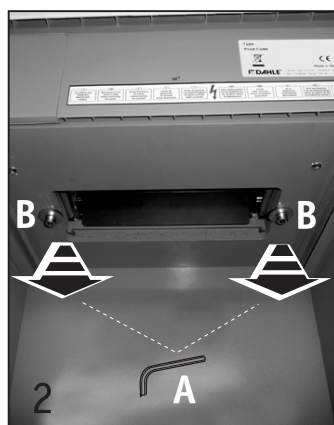

1. Actuate brakes! Prior to placing in operation for the first time, open the door, remove paper collection bin.
2. Remove the screws for the transport lock (paper collection bin compartment) from the base plate underneath the shredding mechanism, re-fit paper collection bin and close door.
3. Each time the appliance is moved, the transport lock is to be re-fitted.

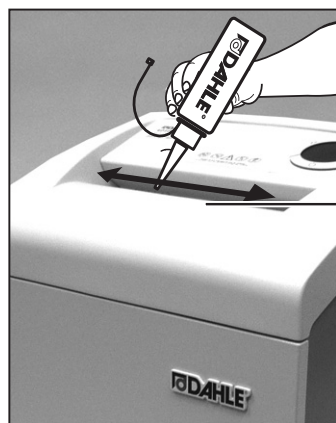

1



2

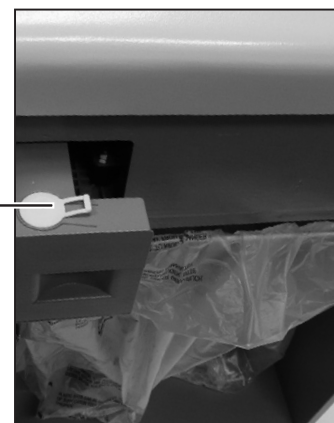

1. Oil the shredding rollers using DAHLE document shredder oil (only cross-cut shredding)!
2. Fill the oil tank using DAHLE document shredder oil!



General information

Depending on the model variant, your document shredder may not have all the possible components and functions.

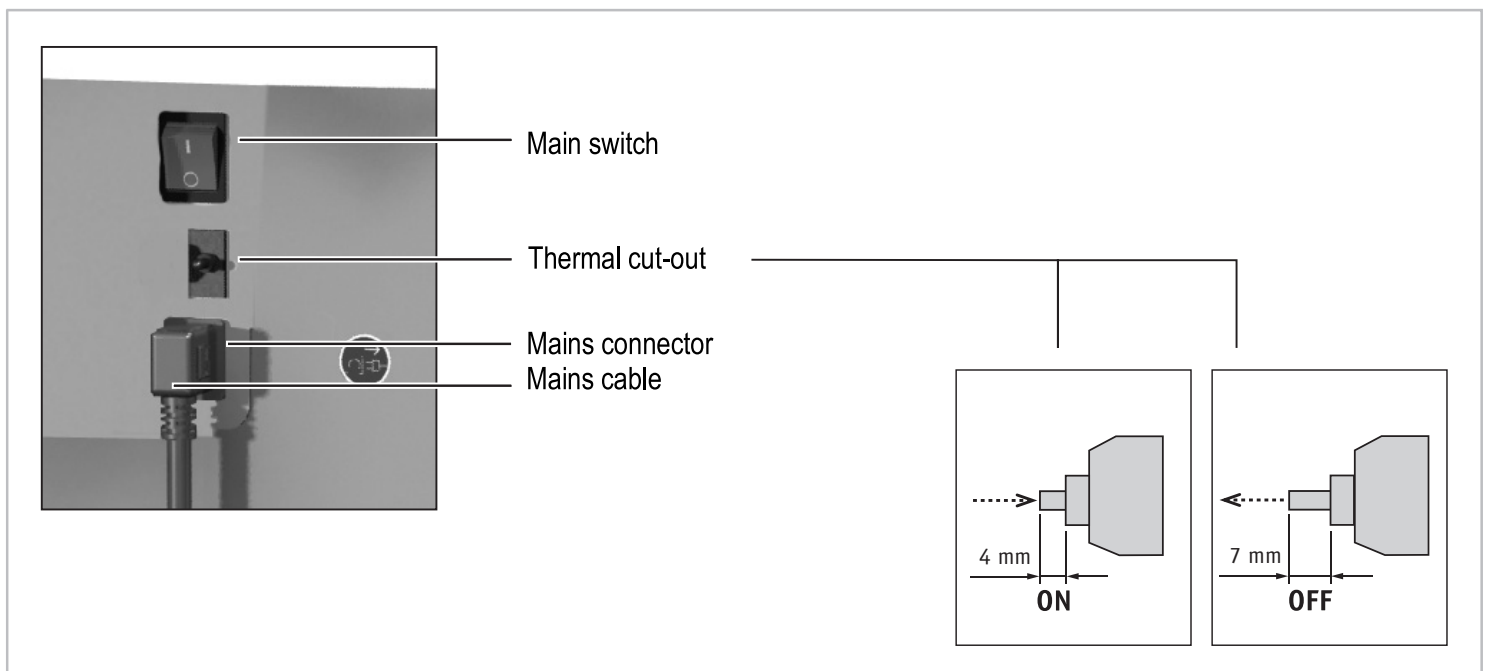
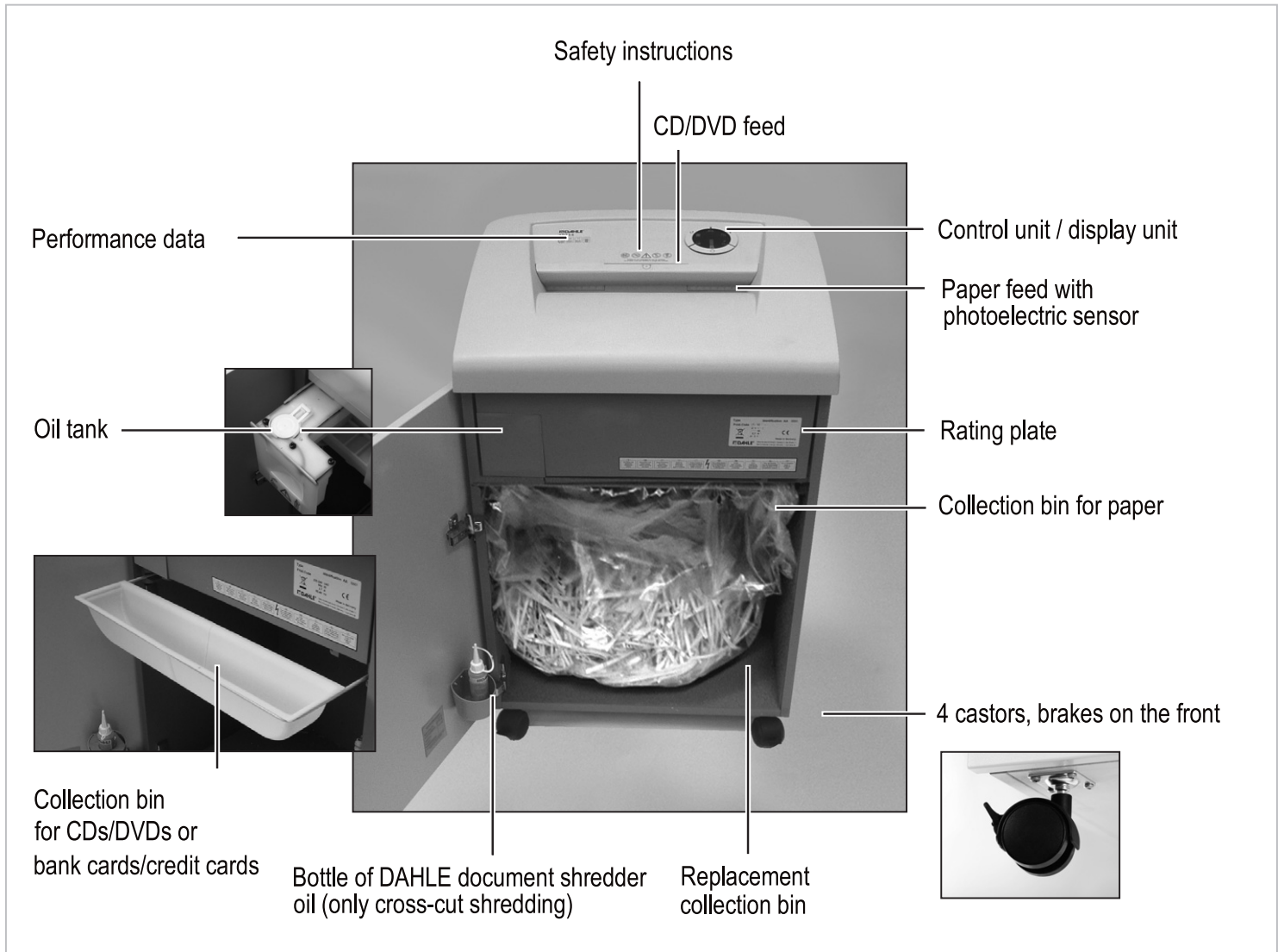



General information

Depending on the model variant, your document shredder may not have all the possible components and functions.

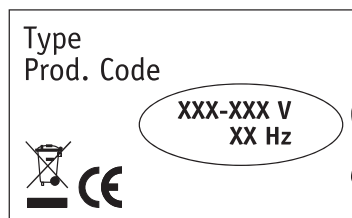
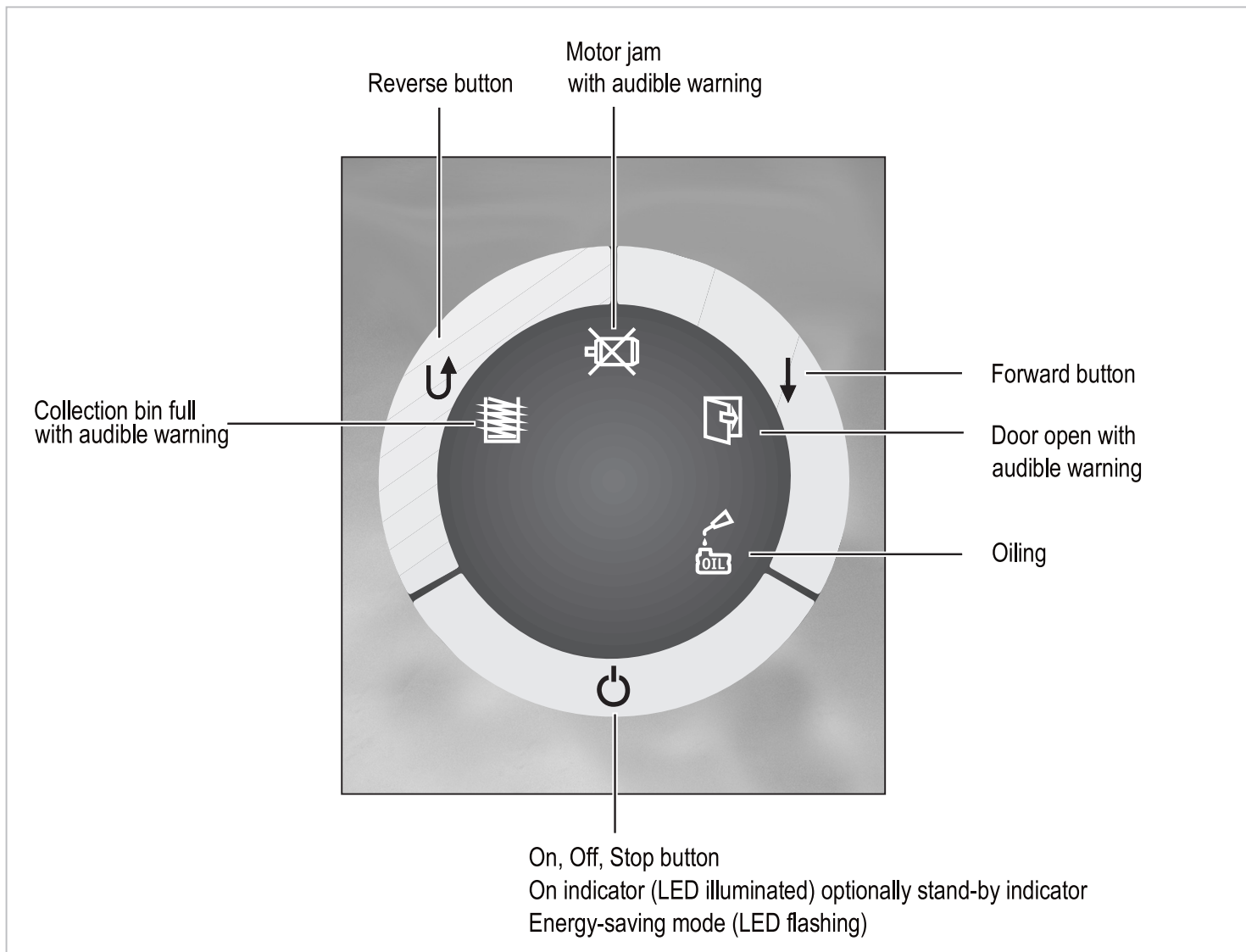

1. Check the voltage and mains frequency of your electricity supply match the information on the rating plate.























Technical data

	DIN A4 - 70 g/m	DIN A4 - 80 g/m					Security level
40204	17	14	3,9 mm				S2
40206	19	16	5,8 mm				S2
40214	10	8		3,9 mm x 40,0 mm			S3
40222	6	5		2,0 mm x 15,0 mm			S4
40230	3	2		0,8 mm x 12,0 mm			S5
40304	23	18	3,9 mm				S2
40306	27	22	5,8 mm				S2
40314	16	13		3,9 mm x 40,0 mm			S3
40322	11	9		2,0 mm x 15,0 mm			S4
40330	6	5		0,8 mm x 12,0 mm			S5
40334	6	5		1,0 mm x 4,7 mm			S6
40404	24	19	3,9 mm				S2
40406	29	23	5,8 mm				S2
40414	16	13		3,9 mm x 40,0 mm			S3
40422	13	10		2,0 mm x 15,0 mm			S4
40430	7	6		0,8 mm x 12,0 mm			S5
40434	6	5		1,0 mm x 4,7 mm			S6



Technical data

			Dimensions H x W x D mm	 kg	Capacity
≤ 46 dB/A	220-240V 50-60Hz 350W 100-120V 50-60Hz 400W		706 x 430 x 347 mm	25,5 kg	40 l
≤ 47 dB/A	220-240V 50-60Hz 350W 100-120V 50-60Hz 400W		706 x 430 x 347 mm	25,5 kg	40 l
≤ 46 dB/A	220-240V 50-60Hz 350W 100-120V 50-60Hz 400W		706 x 430 x 347 mm	25,5 kg	40 l
≤ 47 dB/A	220-240V 50-60Hz 350W 100-120V 50-60Hz 400W		706 x 430 x 347 mm	25,5 kg	40 l
≤ 50 dB/A	220-240V 50-60Hz 350W 100-120V 50-60Hz 400W		706 x 430 x 347 mm	25,5 kg	40 l
≤ 46 dB/A	220-240V 50-60Hz 650W 100-120V 50-60Hz 680W		869 x 546 x 435 mm	40,0 kg	60 l
≤ 47 dB/A	220-240V 50-60Hz 650W 100-120V 50-60Hz 680W		869 x 546 x 435 mm	40,0 kg	60 l
≤ 46 dB/A	220-240V 50-60Hz 650W 100-120V 50-60Hz 680W		869 x 546 x 435 mm	40,0 kg	60 l
≤ 46 dB/A	220-240V 50-60Hz 650W 100-120V 50-60Hz 680W		869 x 546 x 435 mm	40,0 kg	60 l
≤ 47 dB/A	220-240V 50-60Hz 650W 100-120V 50-60Hz 680W		869 x 546 x 435 mm	40,0 kg	60 l
≤ 50 dB/A	220-240V 50-60Hz 650W 100-120V 50-60Hz 680W		869 x 546 x 435 mm	40,0 kg	60 l
≤ 51 dB/A	220-240V 50-60Hz 650W 100-120V 50-60Hz 900W		944 x 546 x 435 mm	43,0 kg	100 l
≤ 51 dB/A	220-240V 50-60Hz 650W 100-120V 50-60Hz 900W		944 x 546 x 435 mm	43,0 kg	100 l
≤ 52 dB/A	220-240V 50-60Hz 650W 100-120V 50-60Hz 900W		944 x 546 x 435 mm	43,0 kg	100 l
≤ 53 dB/A	220-240V 50-60Hz 650W 100-120V 50-60Hz 900W		944 x 546 x 435 mm	43,0 kg	100 l
≤ 52 dB/A	220-240V 50-60Hz 650W 100-120V 50-60Hz 900W		944 x 546 x 435 mm	43,0 kg	100 l
≤ 52 dB/A	220-240V 50-60Hz 650W 100-120V 50-60Hz 900W		944 x 546 x 435 mm	43,0 kg	100 l



















Technical data

	DIN A4 - 70 g/m	DIN A4 - 80 g/m					Security level
40504	33	26	3,9 mm				S2
40506	43	35	5,8 mm				S2
40514	26	21		3,9 mm x 40,0 mm			S3
40522	19	15		2,0 mm x 15,0 mm			S4
40530	11	9		0,8 mm x 12,0 mm			S5
40534	9	7		1,0 mm x 4,7 mm			S6
40604	35	28	3,9 mm				S2
40606	45	36	5,8 mm				S2
40614	30	24		3,9 mm x 40,0 mm			S3
40622	20	16		2,0 mm x 15,0 mm			S4
40630	14	11		0,8 mm x 12,0 mm			S5
40634	11	9		1,0 mm x 4,7 mm			S6



Technical data

			Dimensions H x W x D mm	 kg	Capacity
≤ 47 dB/A	220-240V 50-60Hz 900W 100-120V 50-60Hz 900W		890 x 734 x 510 mm	25,5 kg	140 l
≤ 46 dB/A	220-240V 50-60Hz 900W 100-120V 50-60Hz 900W		890 x 734 x 510 mm	25,5 kg	140 l
≤ 52 dB/A	220-240V 50-60Hz 900W 100-120V 50-60Hz 900W		890 x 734 x 510 mm	25,5 kg	140 l
≤ 53 dB/A	220-240V 50-60Hz 900W 100-120V 50-60Hz 900W		890 x 734 x 510 mm	25,5 kg	140 l
≤ 50 dB/A	220-240V 50-60Hz 900W 100-120V 50-60Hz 900W		890 x 734 x 510 mm	25,5 kg	140 l
≤ 52 dB/A	220-240V 50-60Hz 900W 100-120V 50-60Hz 900W		890 x 734 x 510 mm	40,0 kg	140 l
$\leq 58,5$ dB/A	220-240V 50-60Hz 1650W 100-120V 50-60Hz 1650W		960 x 734 x 510 mm	40,0 kg	160 l
≤ 56 dB/A	220-240V 50-60Hz 1650W 100-120V 50-60Hz 1650W		960 x 734 x 510 mm	40,0 kg	160 l
≤ 57 dB/A	220-240V 50-60Hz 1650W 100-120V 50-60Hz 1650W		960 x 734 x 510 mm	40,0 kg	160 l
$\leq 55,5$ dB/A	220-240V 50-60Hz 1650W 100-120V 50-60Hz 1650W		960 x 734 x 510 mm	40,0 kg	160 l
≤ 60 dB/A	220-240V 50-60Hz 1650W 100-120V 50-60Hz 1650W		960 x 734 x 510 mm	40,0 kg	160 l
≤ 62 dB/A	220-240V 50-60Hz 1650W 100-120V 50-60Hz 1650W		960 x 734 x 510 mm	40,0 kg	160 l



Operation - shredding paper

Depending on the model variant, your document shredder may not have all the possible components and functions.

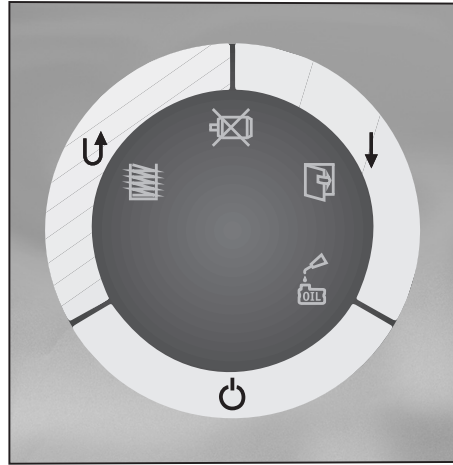

Please follow the safety instructions.

1. Prior to using the document shredder, please check the position of the collection bin for CDs/DVDs and bank cards/credit cards. On shredding paper this bin must be at the front of the collection bin for paper.
2. Close the door of the document shredder.
3. Connect the mains cable supplied to the document shredder and plug into a mains socket. Switch on the main switch.
4. Switch on the document shredder with the On, Off, Stop button.

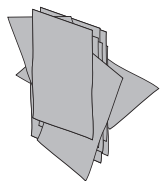

O.K.



1. Pay attention to maximum number of sheets of paper in the technical data!
2. Place the paper in the middle of the paper feed, the built-in photoelectric sensor starts the document shredder automatically.
3. Once the paper feed is clear again, the document shredder switches off automatically and goes into stand-by.
4. Continuous operation - after extended operation (approx. 5 sec.) of the forward button, the document shredder changes to continuous operation.
5. If the supply of paper is interrupted for 15 seconds, continuous operation is interrupted.



Operation - shredding CDs/DVDs & bank cards

Depending on the model variant, your document shredder may not have all the possible components and functions.

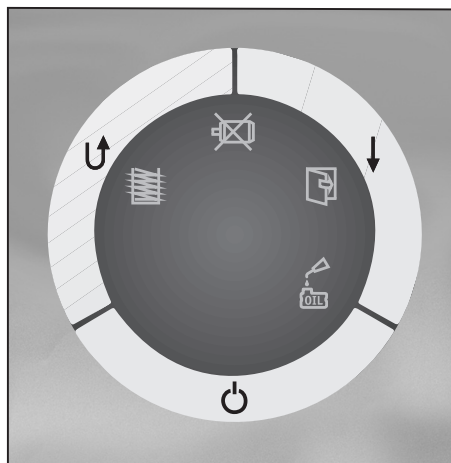

Please follow the safety instructions.

1. Prior to using the document shredder, please check the position of the collection bin for CDs/DVDs and bank cards/credit cards. On shredding CDs/DVDs and bank cards/credit cards this bin must be at the rear of the collection bin for paper.
2. Pull out collection bin and position the collection bin for CDs/DVDs and credit cards/bank cards at the rear.
3. Close the door of the document shredder.

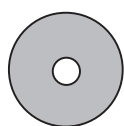

1. Insert the CDs, DVDs or bank cards/credit cards in the middle of the feeder while keeping the Forward button pressed.
2. Once the CD/DVD feed is clear again, the document shredder switches off automatically and goes into stand-by.

! Significance of the signals

Depending on the model variant, your document shredder may not have all the possible components and functions.

Collection bin full - the LED flashes and an audible warning sounds.



1.

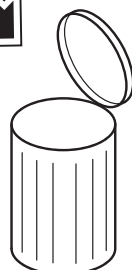
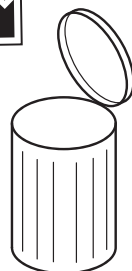
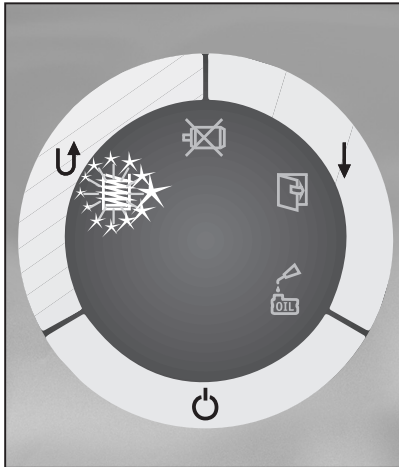

1. If the collection bin is full, the shredding process is stopped, this situation is indicated acoustically and optically.
2. Switch off the main switch and unplug the mains cable from the mains socket.
3. Remove collection bin, empty and re-fit.
4. Plug the mains cable into the mains socket and switch on the main switch.



Significance of the signals

Depending on the model variant, your document shredder may not have all the possible components and functions.

Automatic motor shut down - the LED flashes and an audible warning sounds.

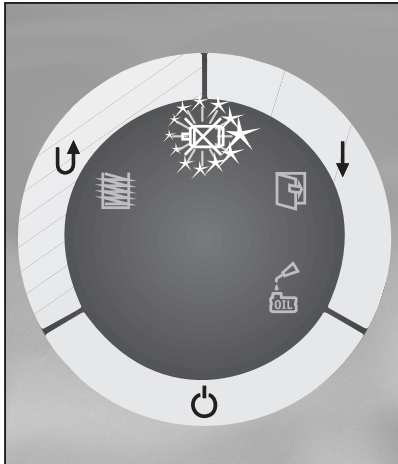

1. Automatic motor shut down with audible warning in case of:

- Overheating of the motor
- Paper jam

Door open - the LED flashes and an audible warning sounds.

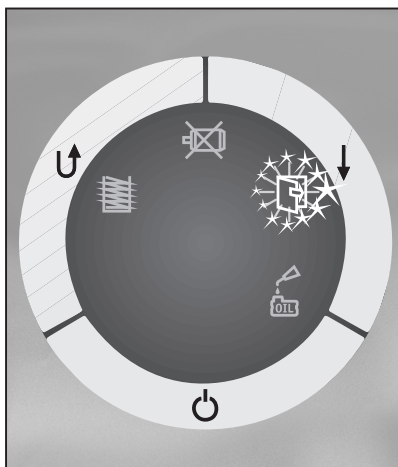
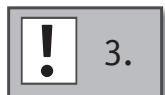

1. If the door is open, the shredding process is stopped and a signal sounds, close the door.



Significance of the signals

Depending on the model variant, your document shredder may not have all the possible components and functions.

Oiling - the LED flashes.

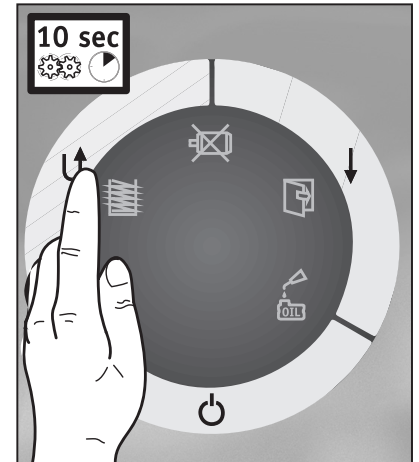
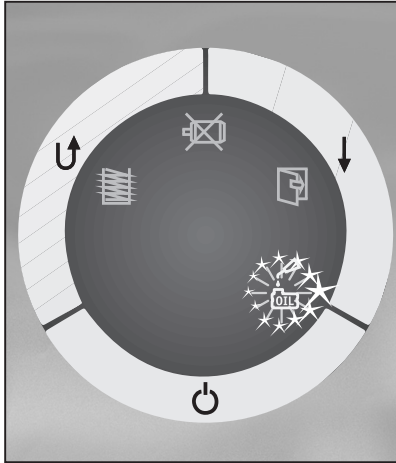

Oil the shredding mechanism if the shredding performance drops (only for cross-cut shredding S3 and S4).

1. Switch off the document shredder with the On, Off, Stop button.
Oil the shredding rollers manually (use DAHLE document shredder oil!).
2. Switch on the document shredder with the On, Off, Stop button, leave shredding mechanism to run in reverse without paper feed.
3. Reset oil indication
Keep the Forward and Reverse button pressed for approx. 5 seconds.



Significance of the signals

Depending on the model variant, your document shredder may not have all the possible components and functions.

Automatic oiling - only for cross-cut shredding

Fill oil tank with DAHLE document shredder oil.

Integrated oil tank for regulated, automatic oiling of the rollers.



5.1

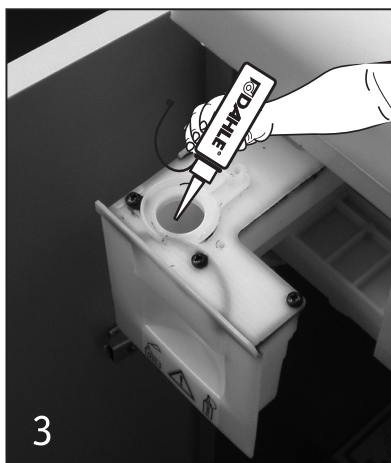
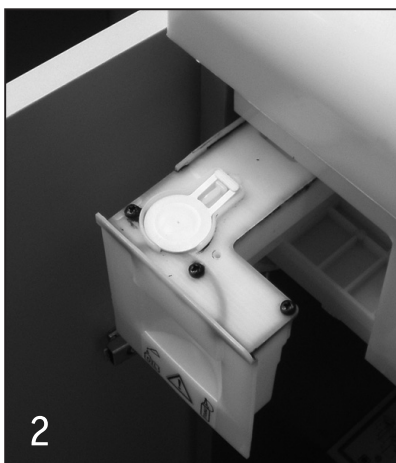
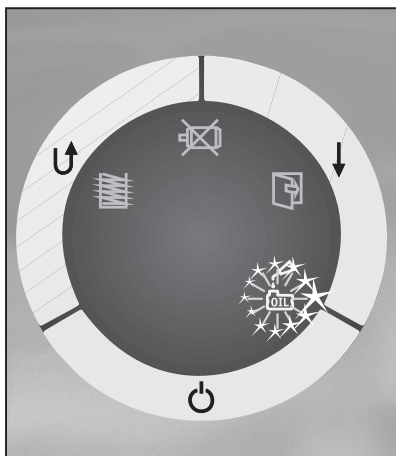

Fill the integrated oil tank in the document shredder in case of indication on the display.

1. Switch off the document shredder with the On, Off, Stop button.
2. Open the door, the integrated oil tank is in the cabinet, open the cap.
3. Fill oil tank with oil (use DAHLE document shredder oil!) and close again.



5.1

Attention - 115 V

It is only possible to shred paper after filling (use DAHLE document shredder oil!) the oil tank.

? Possible malfunctions

Depending on the model variant, your document shredder may not have all the possible components and functions.

? 1.

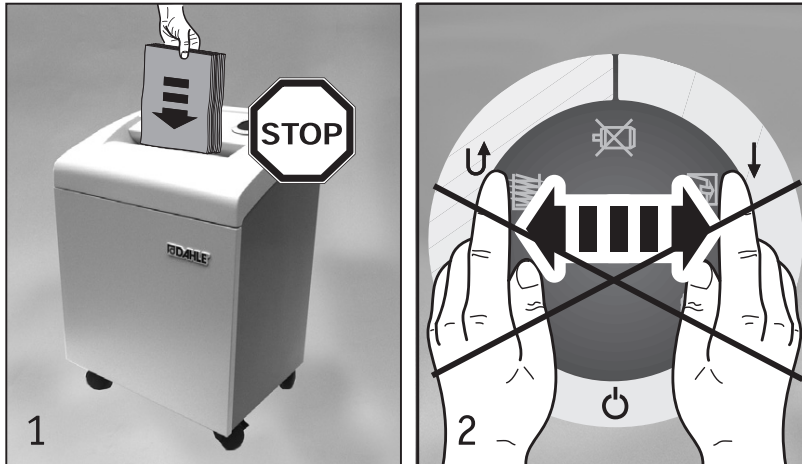

1. If there are too many sheets of paper, the shredding process is stopped.
2. The shredding mechanism automatically runs in reverse for a short time and the paper is ejected.
3. ATTENTION! To avoid damaging the shredding mechanism, do not operate the forward-reverse switch alternately!

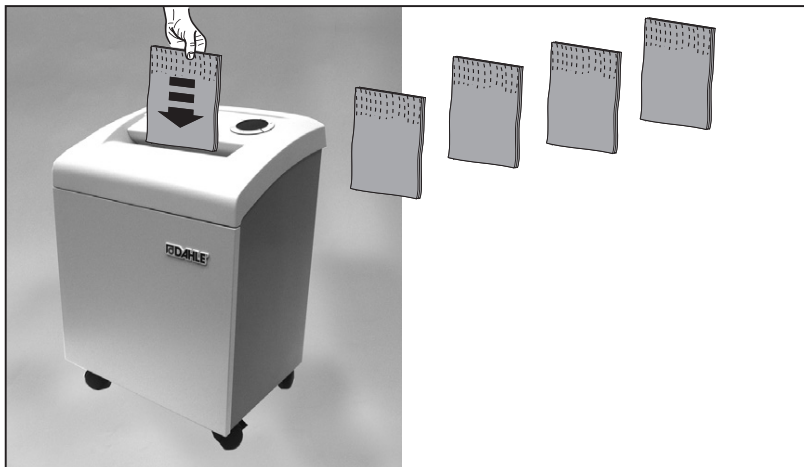

4. If paper continues to be jammed, operate the Reverse button briefly.
5. Reduce the number of sheets of paper by removing or tearing off.
6. The shredding process starts automatically after the paper is inserted again, otherwise operate the Forward button.

40334, 40434, 40534, 40634

1. In the event of a paper jam, the shredding mechanism runs in reverse for 0.5 seconds.
2. Remove the paper. Then operate the Forward switch to clear the shredding mechanism.
The Reverse switch is inhibited until the Forward switch has been actuated.
3. Reduce the number of sheets of paper.

? Possible malfunctions

Depending on the model variant, your document shredder may not have all the possible components and functions.

? 2.



The document shredder switches off automatically after extended operation and/or overheating to cool down.

? 3.

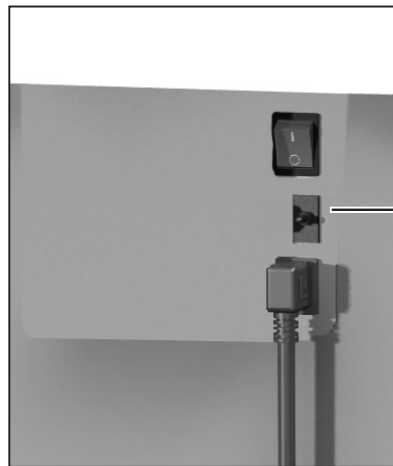

1. The shredding process is not started:

1.1 LED not illuminated

- Mains cable not plugged into the mains socket?
- Main switch not on?
- On, Off, Stop button not switched on?
- Thermal cut-out OFF?

1.2 LED illuminated

- Door open?
- Collection bin full?
- Overload?
- Oil tank empty (115 V)?

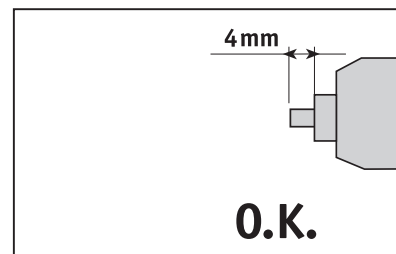
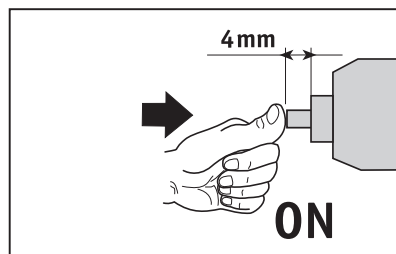
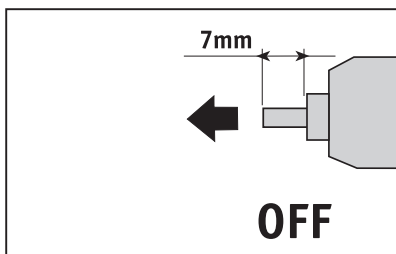

Place the thermal cut-out in the correct position - ON.

? Possible malfunctions

Depending on the model variant, your document shredder may not have all the possible components and functions.

Energy-saving mode

? 4.



If not used, the document shredder switches to the energy saving mode (flashing LED) after approx. 10 minutes. On renewed use, the document shredder requires approx. 3 seconds to start.

In the energy-saving mode the document shredder switches off if it is not used after approx. 20 minutes (LED off). To use the document shredder, switch it back on with the On, Off, Stop button.



Maintenance and care

Use only DAHLE spare parts!

? 1.



1. Switch off the document shredder and unplug the mains cable from the mains socket.
2. Only clean the appliance with a dry cloth.
3. Plug the mains cable into the mains socket, switch on the document shredder.

Dahle Bürotechnik GmbH
Postfach 11 10
96466 Rödental | Germany
Nikolaus-A.-Otto-Straße 11
96472 Rödental | Germany
Tel.: +49 9563 75299-0
Fax: +49 9563 75299-333
E-Mail: dahle@dahle.de
Internet: www.dahle.de